

**Introduction
to
Theory of Computing**

Peter Kogge

From The Dictionary

- **Theory**: system of ideas intended to explain something
 - Especially based on general principles independent of thing being explained
- **Computing**: (from Latin) to come together (to settle an account)
- **Philosophy**: study of the fundamental nature of knowledge, reality, and existence

**This Class: a study of the
fundamental nature and
limits of computation**

The Matching Problem

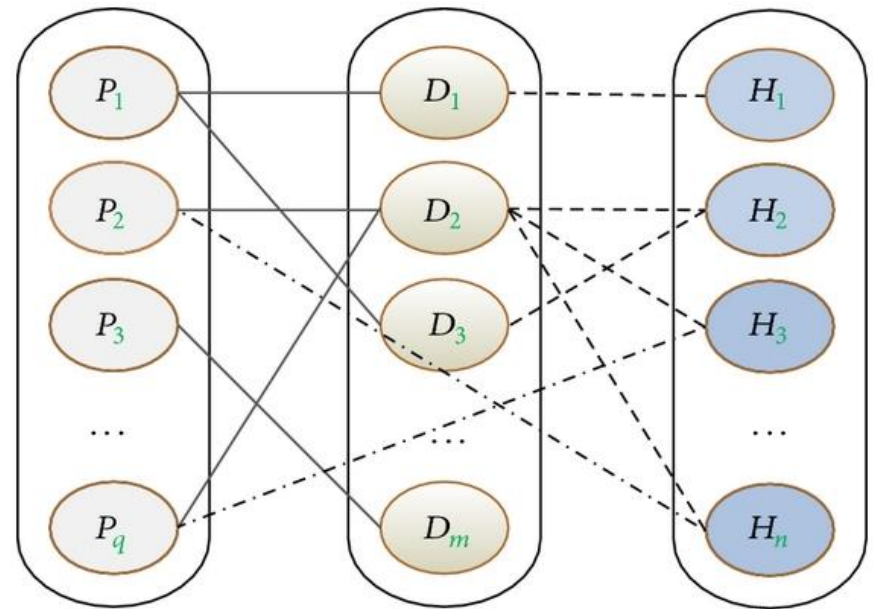
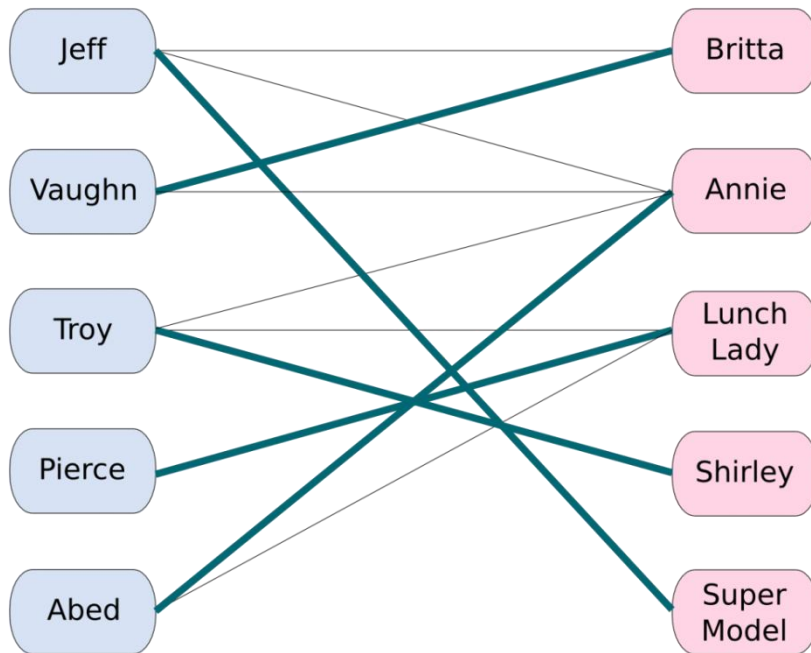

**Bipartite Matching: a.k.a
2-Gender marriage problem:
Solvable in “polynomial” time
 $O(V^{2.4})$ or $O(E^{10/7})$**

https://www.researchgate.net/profile/Simon_Poon/publication/279225880/figure/fig1/AS:301952400412694@1449002470456/Tripartite-graph-structure-of-TCM-Here-instances-of-different-objects-are-represented.png

**3-Gender marriage problem:
Known to be “NP-Hard”
Probably exponential: $O(2^V)$**

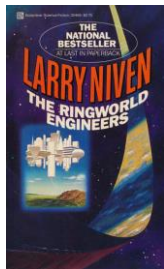

It continues to be $O(2^V)$ for more than 3 genders

Does It Matter to a Match-Making Computer?

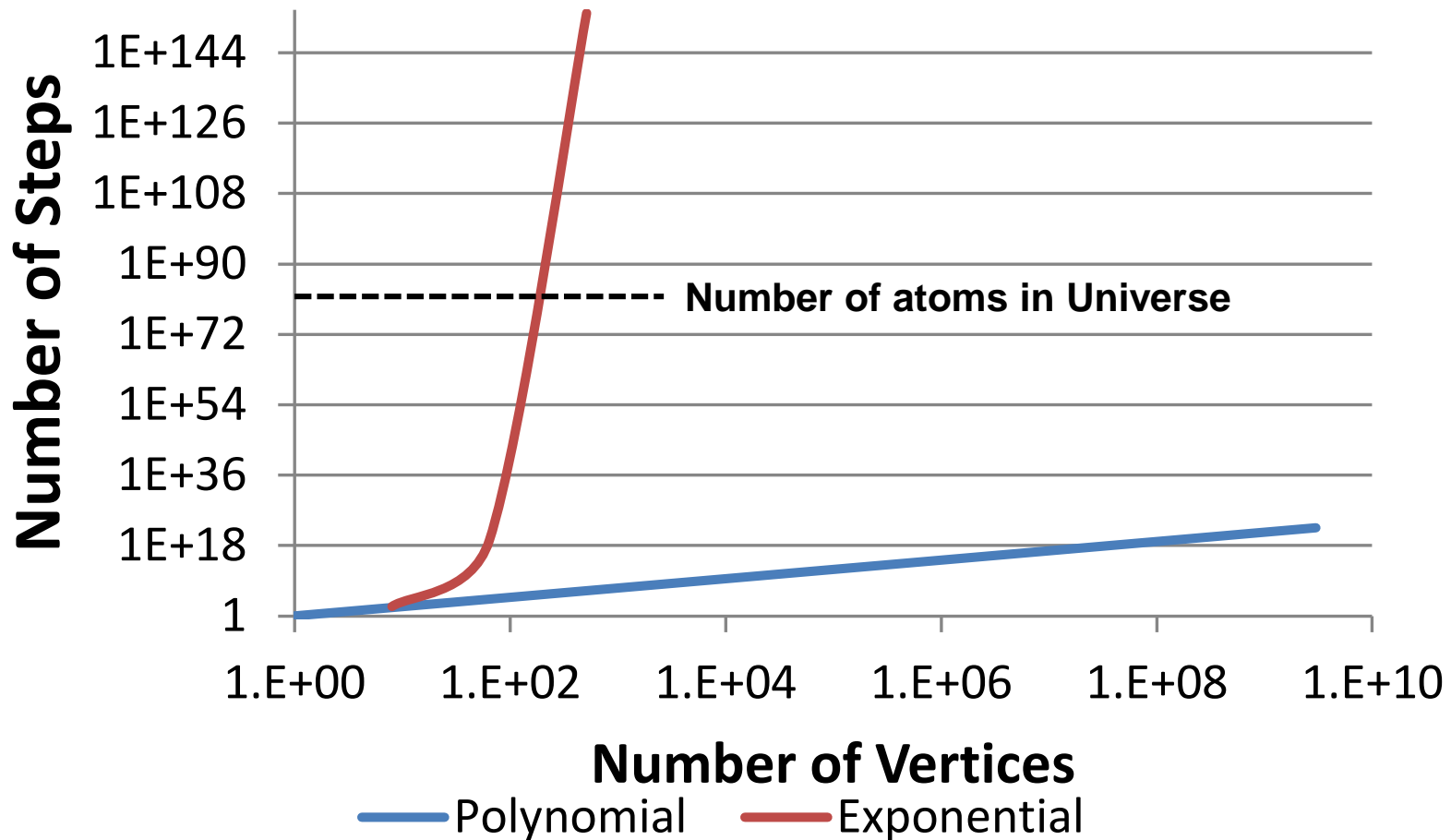

Problems requiring exponential # of steps are ***HARD!!***

Another Example:

Boolean Satisfiability (SAT)

- ❑ **SAT**: Is there a assignment of values to variables in a Boolean expression making it true
- ❑ **Example**: $(\sim x \vee y) \& (x \vee y) \& (x \vee \sim y)$
 - $x=1, y=1$ makes expression true
- ❑ **Example**: $(\sim x \vee y) \& (x \vee y) \& (x \vee \sim y) \& (\sim x \vee \sim y)$
 - No assignment of values make expression true
- ❑ **Trivial algorithm**: create truth table to test all possible cases ($2^{|V|}$)
- ❑ **Can we do better?**

SAT is perhaps **THE** fundamental problem in computing!

Key Questions for Such Problems

- What is it that we “count” when discussing “how hard” a problem is?
- Are there variations in our basic model of computing?
- What classes of problems are solvable by each model?
- Why are some problems “hard”?
- Is there a “universal problem”?
- Is there a “universal computing model”?
- Are there problems that are intrinsically hard even on a universal computer?

Computing Theory In Perspective

- ❑ **Architecture**: Design of inhabitable structures
- ❑ **Organization**: Functional interaction of Key Subsystems
- ❑ **Design**: Implementation in a real technology
- ❑ **Execution Model**: How a computer executes a program
- ❑ **Algorithm**: Step-by-step description of a computation to solve some problem
- ❑ **Programming Model**: Expression of Algorithm in form that executes on a real computer

Particularly Relevant

- ❑ **Abstract Machine**: simplified model of a class of computer systems
 - Today's computers are all **von Neumann**
- ❑ **Automata Theory**: formal definitions of 3 basic classes of abstract machines
- ❑ **Complexity Theory**: what makes some problems intrinsically hard and others simple?
- ❑ **Computability Theory**: what problems can be solved by algorithms executable on what classes of automata

Classes of Automata

- ❑ **Automata:** (Greek for “self-acting”) Device that
 - Accepts strings of input data one character at a time
 - Generates an output (at some point)
 - Fixed set of **states** it can be in
 - Follows a stored set of **transition rules**
 - For each input & current state, what is new state
- ❑ **Finite Automata:** No memory other than state
 - **Deterministic (DFA):** transition rules id at most only 1 new state
 - **NonDeterministic (NFA):** multiple transitions possible
- ❑ **Push Down Automata (PDA):** Stack available of intermediate results
- ❑ **Turing Machines (TM):** Infinite tape available for intermediate results

Today: Turing Machines Rule!

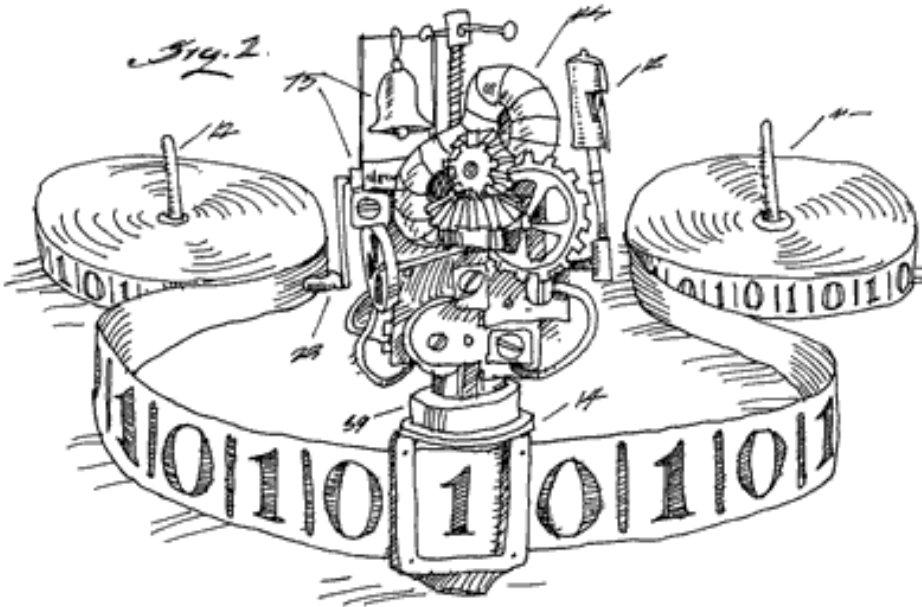

<http://www.worldofcomputing.net/theory/turing-machine.html>

Turing Machine:

1. Read a character from a tape
2. Get operation from table lookup
3. Write a character to tape
4. Move tape left or right
5. Repeat

The Von Neumann or Stored Program architecture

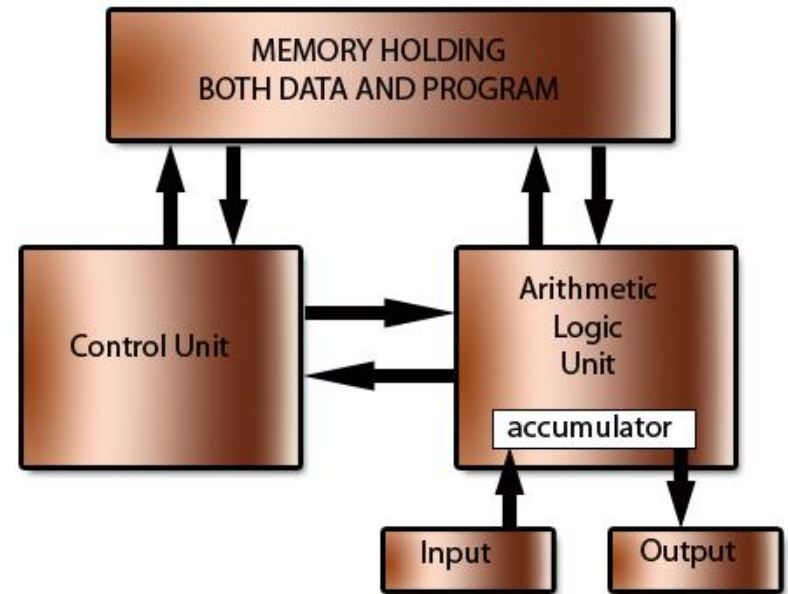

(c) www.teach-ict.com

http://www.teach-ict.com/as_as_computing/ocr/H447/F453/3_3_3/vonn_neuman/miniweb/images/von_newmann_architecture.jpg

Von Neumann Architecture:

1. Read instruction from memory
2. Read a datum from memory
3. Do an operation
4. Determine next instruction
5. Repeat

More on Language Definitions

- ❑ **Alphabet**: set of characters that can be used in a program
- ❑ **Symbol**: member of an alphabet
- ❑ **Syntax**: formal rules for valid substrings
- ❑ **Grammar**: expression of syntax rules
- ❑ **Semantics**: formal description of what valid strings mean in terms of algorithm execution

Classes of Languages

- **Language Recognition**: transition rules can be generated to
 - Say YES for any input string if in that language
 - Say NO for any input string not in that language
- **Regular Expressions**: can be recognized by FA
- **Context Free**: can be recognized by PDA
- **Context Sensitive** and **Unrestricted**: can be recognized by a Turing Machine

A Simple Finite Automata

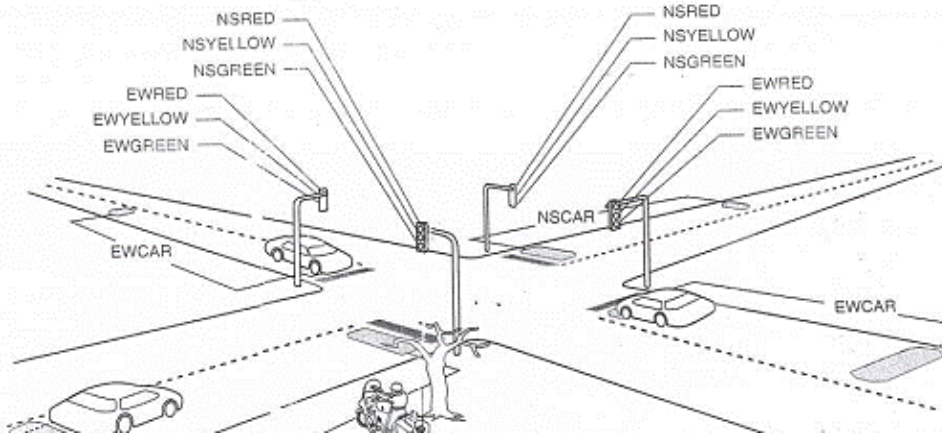

State Diagram Representation

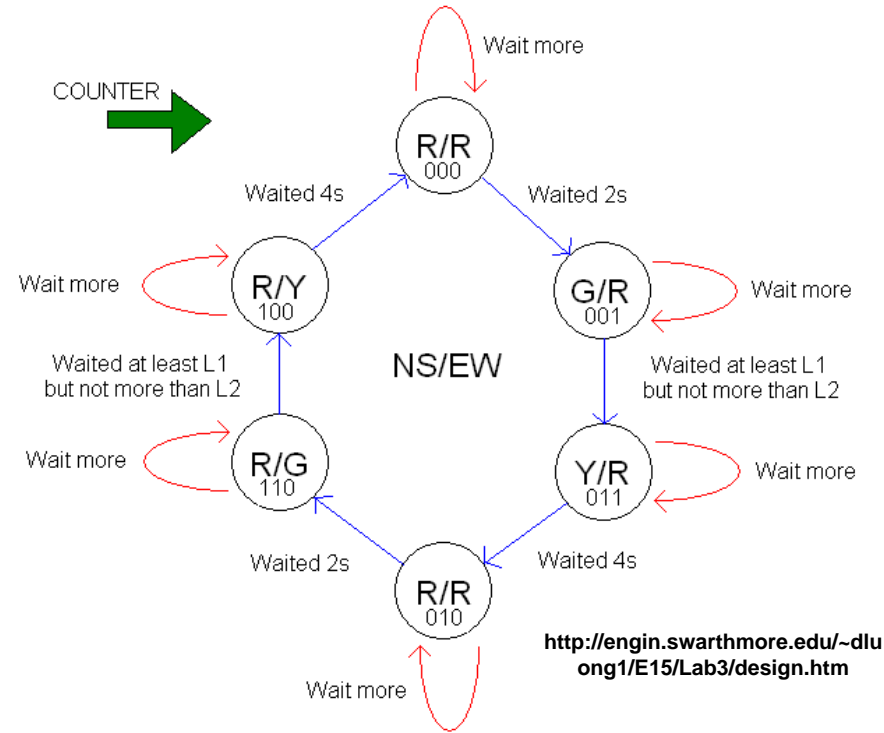

Transition Function Representation

$\delta(\text{current_state}, \text{input}) = \text{new_state}$

e.g.

$\delta(\text{G/R}, \text{ewcar}) = \text{Y/R}$

A “Multi-dimensional” Automata

Conway’s “Game of Life”

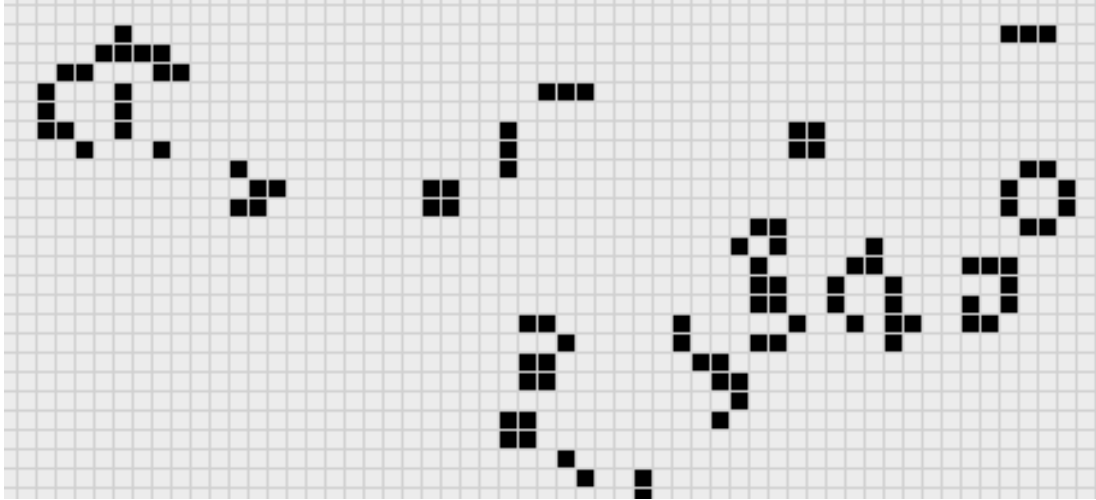

<http://www.math.cornell.edu/~lipa/mec/lesson6.html>

A “live” cell dies if

- Less than 2 live neighbors
- Greater than 3 live neighbors

A dead cell becomes “alive” if

- exactly 3 live neighbors

Rationale for these choices:

- No initial pattern for which there is a simple proof that the population can grow without limit.
- There should be initial patterns that apparently do grow without limit.
- There should be simple initial patterns that grow and change for a considerable period of time before coming to an end in the following possible ways:

Fading away completely (from overcrowding or too sparse)

Settling into a stable or oscillating pattern.

			0
7	8	9	/
4	5	6	X
1	2	3	-
0		=	+

- What are valid inputs?
- What is output?
- What is operation?
- What is “language” that is accepted?
- How much memory is here?

Describe the Calculator's Operation

If you press	The calculator does the following
0,1,2,3,4,5, 6,7,8,9	
+, -, *, /	
=	

Food for Thought: What happens if you press a digit after “=”?

Describe the Calculator's Operation

Notional "Transition Table"

If you press	The calculator does the following
0,1,2,3,4,5, 6,7,8,9	Shift Display left and insert digit
+, -, *, /	<ul style="list-style-type: none">• Remember the operation• Remember current displayed #• Reset display # to 0
=	Compute: Remembered # "operation" Displayed #, and display result

Food for Thought: What happens if you press a digit after "="?

A Subset of a “State Diagram”

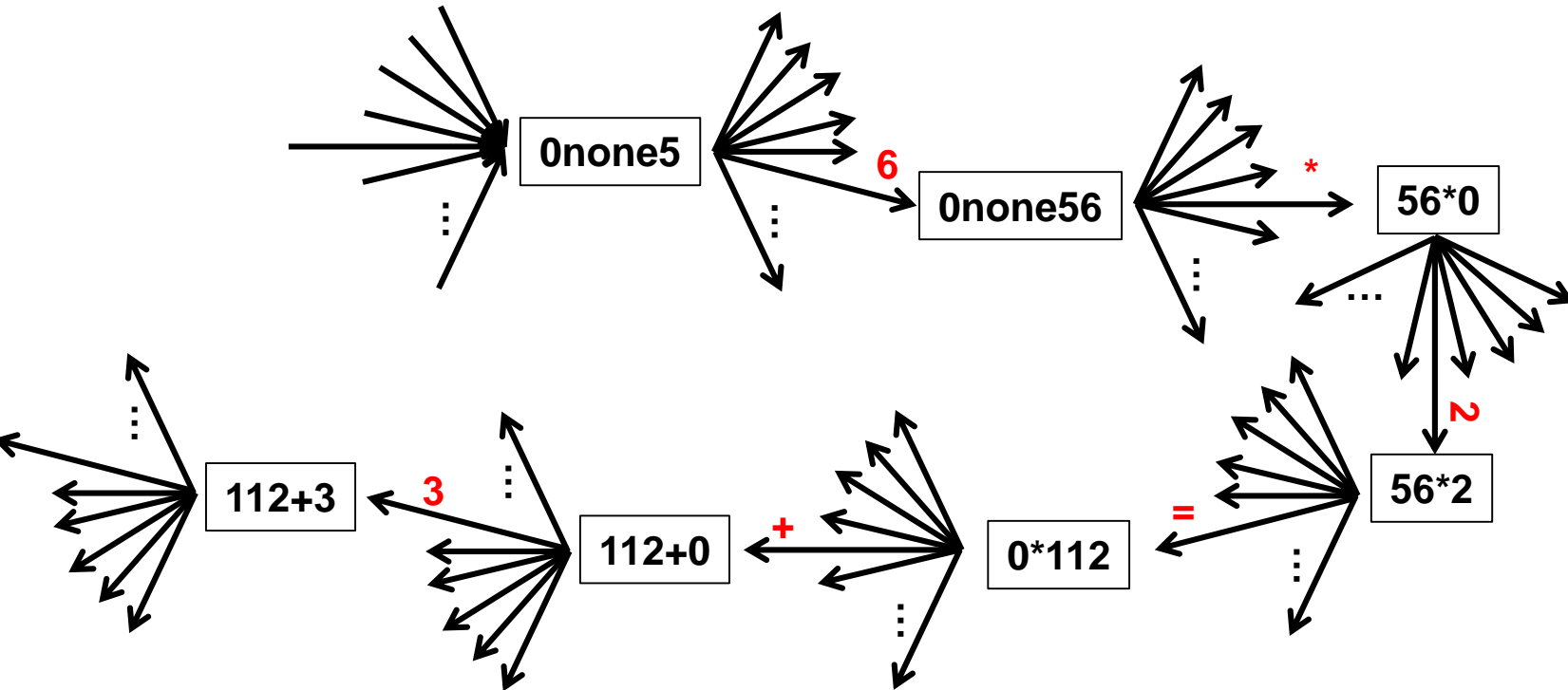

ixj is “state” where “i” is saved #, j is displayed #, and “x” is last operator
“none” represent no operation pushed since power on

Symbol on edge is a button push

Alternative: Transition Function

- δ is denoted as the **Transition Function**
- $\delta(\text{current_state}, \text{input}) = \text{new_state}$
- If state represented as “ixj” where
 - “i” is last # saved in calculator
 - “j” is number currently being displayed
 - “x” is last operation button pushed
- Then some sample entries for δ include
 - $\delta(2+3, 5) = 2+35$ (push 5 onto right of displayed #)
 - $\delta(2+35, “=”) = 0=70$
 - Many, many more, but finite # of them

What's the "Abstract Machine?"

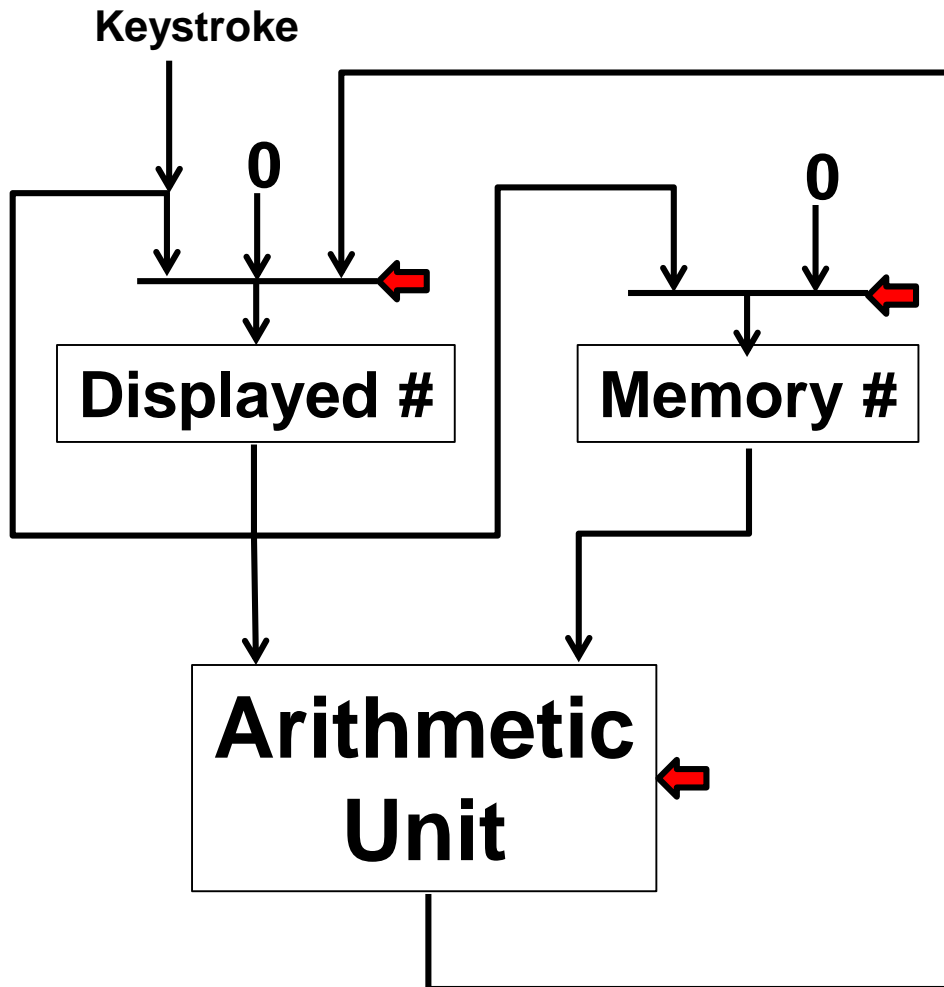

SavedOperation

Keystroke	State 1		State 2		...		State N	
	Operation	Next State	Operation	Next State			Operation	Next State
0								
1								
2								
3								
4								
5								
6								
7								
8								
9								
+								
-								
*								
/								
=								

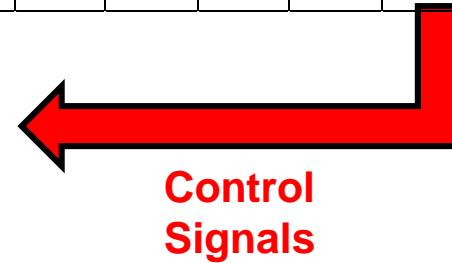

State = concatenate(Displayed#,memory#,SavedOperation) - - - - -

Can We Compute ALL Expressions

- ❑ Can we compute $12 * 34 + 56 / 78 = ?$
- ❑ Can we compute $12 * 34 + 45 * 67 = ?$
- ❑ What is the computable language?

$\langle \text{digit} \rangle \rightarrow 0 \mid 1 \mid 2 \mid 3 \mid 4 \mid 5 \mid 6 \mid 7 \mid 8 \mid 9$ ← Symbol

$\langle \text{number} \rangle \rightarrow \langle \text{digit} \rangle \mid \langle \text{number} \rangle \langle \text{digit} \rangle$

$\langle \text{op} \rangle \rightarrow + \mid - \mid * \mid /$

$\langle \text{expression} \rangle \rightarrow \langle \text{number} \rangle \mid \langle \text{expression} \rangle \langle \text{op} \rangle \langle \text{number} \rangle =$

← Meta-symbol

↑ Non-terminal

This kind of grammar notation is often called “BNF”

Does This Change Anything?

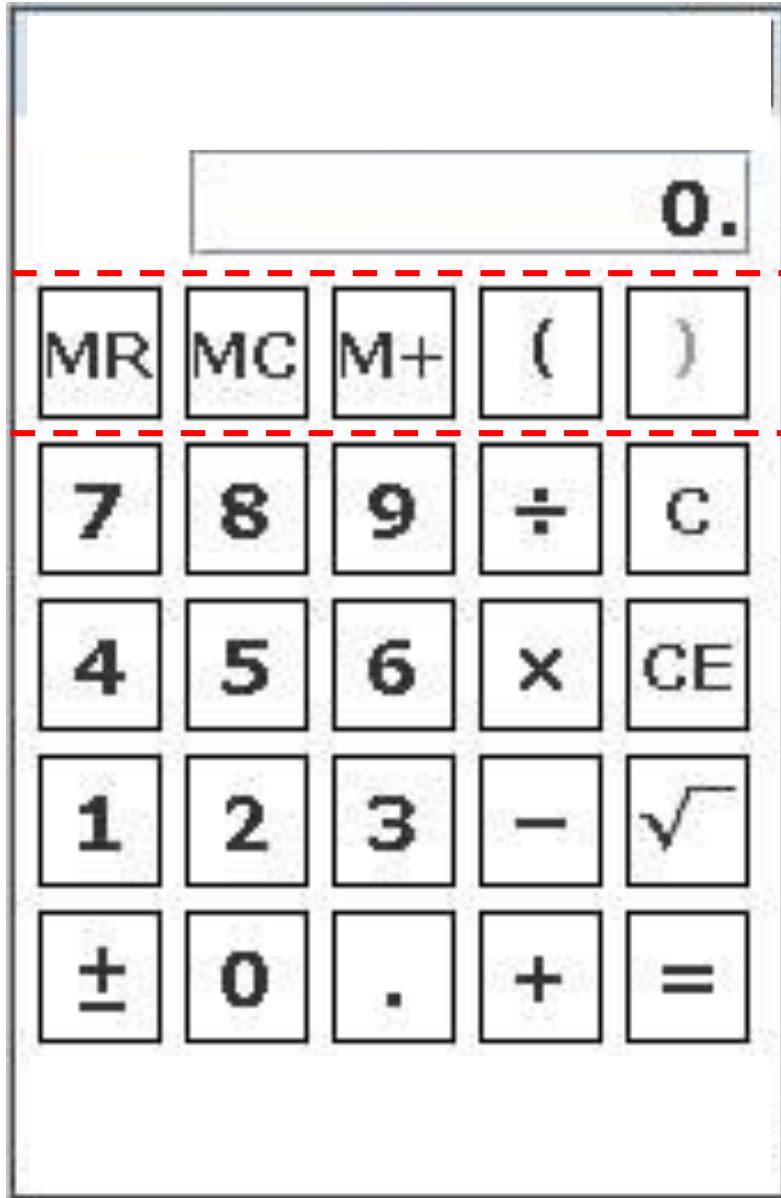

- What are valid inputs?
- What is output?
- What is “language” that is accepted?
- How much memory is here?

More Food for Thought?

Virus

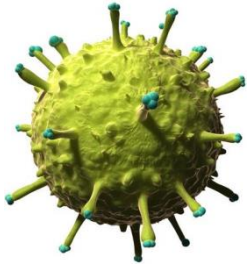

<http://pop.h-cdn.co/assets/15/23/980x490/landscape-1433433160-virus-swineflu.jpg>

Cyanobacteria

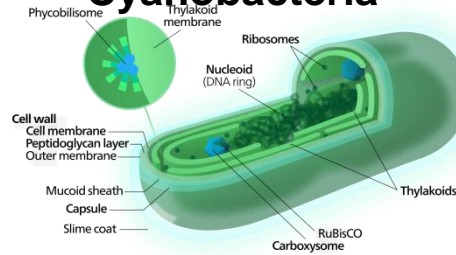

<https://upload.wikimedia.org/wikipedia/commons/thumb/5/58/Cyanobacterium-inline.svg/2000px-Cyanobacterium-inline.svg.png>

Euglena

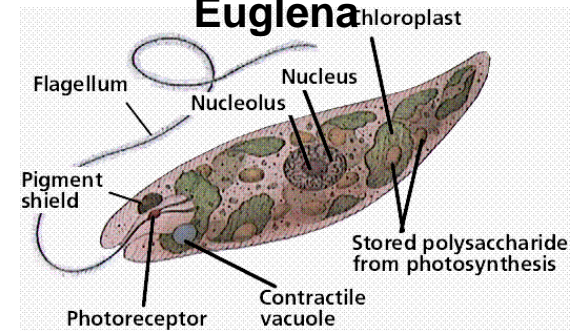

<http://www.schurstrophotography.com/roboimages/visionlogic/onepixeleye/euglena.gif>

Jellyfish

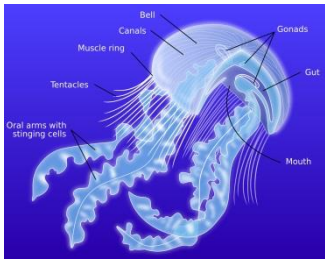

https://upload.wikimedia.org/wikipedia/commons/thumb/6/6b/Anatomy_of_a_jellyfish-en.svg/2000px-Anatomy_of_a_jellyfish-en.svg.png

Earthworm

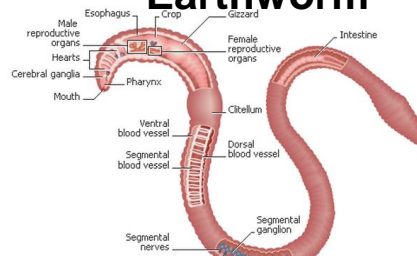

<https://www.google.com/url?sa=i&rct=j&q=&esrc=s&source=images&cd=&cad=rja&act=8&ved=0ahUKEwiOhrfncn0AhVTSYKH5FAA0QJRwiBw&url=http%3A%2F%2Fearthwormresources.weebly.com%2FReproduction-and-development.html&psig=AFQjCNGKaHGRVTCQI2BSAKXPjAl-PLQ&ust=1471550174895324>

Cockroach

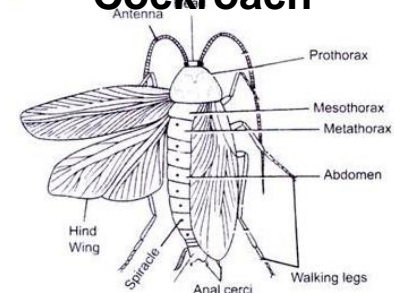

http://www.biologydiscussion.com/wp-content/uploads/2014/09/clip_image002_thumb18.jpg



https://www.google.com/url?sa=i&rct=j&q=&esrc=s&source=images&cd=&cad=rja&act=8&ved=0ahUKEwip2dbFp9DAhVDM5YKHTY5AuQJRwiBw&url=http%3A%2F%2Fscicurious.scientopia.org%2F2013%2F07%2F19%2Ffriday-wired-science-mopsy-mice-pee-their-feelings%2F&psig=AFQjCNGv26Ld_N19E2vUByxJeOxL2HKRQ&ust=1471550607879756



https://images-na.ssl-images-amazon.com/images/G/01/img15/pet-products/small-tiles/23695_pets_vertical_store_dogs_small_tile_8_CB312176604_jpg



http://i.dailymail.co.uk/pix/2011/11/01/article-0-0C1D46100000578-689_468x482.jpg



<http://winnebago.com/wp-content/uploads/2013/06/HR-People.jpg>

What's Next?

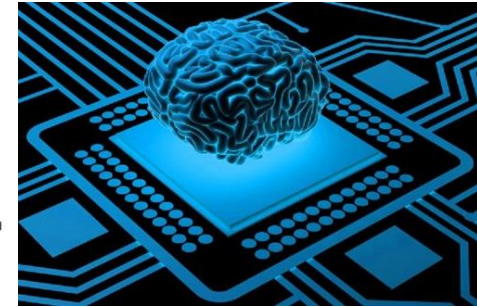
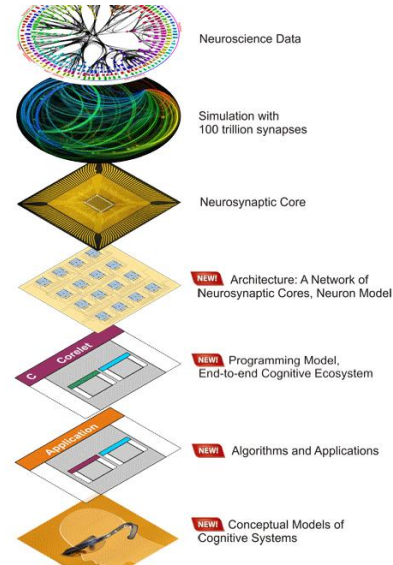

<https://media.licdn.com/mpr/mpr/AEEAAQAAAAAXLAAAJD15N2M1ZmJmLWJiODQ1NDkZC1iZTRmLWY4N2ViNDA1MmE1ZQ.jpg>

http://3.bp.blogspot.com/-y4yiZzcyyDk/UgO_gBocm-IAAAAAAAnMA/ISvU3OkdgEo/s1600/synapsestack.png

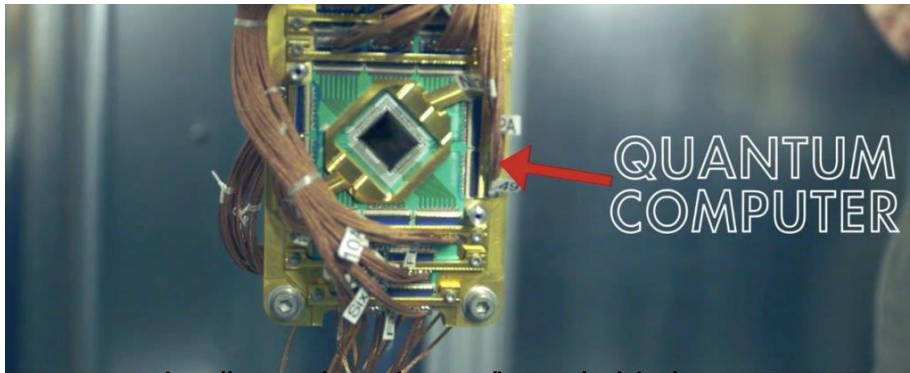

http://www.sciencealert.com/images/articles/processed/quantum-computer_1024.jpg



<https://www.skotcher.com/wall/12ea2fc3e99298fdd4d12a13c69a2c56/2001-a-space-odyssey-hurricane-monoilth-planets-starlight.jpg>